

MC60-TE-A User Guide

GSM/GPRS/GNSS Module Series

Rev. MC60-TE-A_User_Guide_V2.0

Date: 2016-09-27



Our aim is to provide customers with timely and comprehensive service. For any assistance, please contact our company headquarters:

Quectel Wireless Solutions Co., Ltd.

Office 501, Building 13, No.99, Tianzhou Road, Shanghai, China, 200233

Tel: +86 21 5108 6236

Email: info@quectel.com

Or our local office. For more information, please visit:

<http://www.quectel.com/support/salesupport.aspx>

For technical support, or to report documentation errors, please visit:

<http://www.quectel.com/support/techsupport.aspx>

Or email to: Support@quectel.com

GENERAL NOTES

QUECTEL OFFERS THE INFORMATION AS A SERVICE TO ITS CUSTOMERS. THE INFORMATION PROVIDED IS BASED UPON CUSTOMERS' REQUIREMENTS. QUECTEL MAKES EVERY EFFORT TO ENSURE THE QUALITY OF THE INFORMATION IT MAKES AVAILABLE. QUECTEL DOES NOT MAKE ANY WARRANTY AS TO THE INFORMATION CONTAINED HEREIN, AND DOES NOT ACCEPT ANY LIABILITY FOR ANY INJURY, LOSS OR DAMAGE OF ANY KIND INCURRED BY USE OF OR RELIANCE UPON THE INFORMATION. ALL INFORMATION SUPPLIED HEREIN IS SUBJECT TO CHANGE WITHOUT PRIOR NOTICE.

COPYRIGHT

THE INFORMATION CONTAINED HERE IS PROPRIETARY TECHNICAL INFORMATION OF QUECTEL CO., LTD. TRANSMITTING, REPRODUCTION, DISSEMINATION AND EDITING OF THIS DOCUMENT AS WELL AS UTILIZATION OF THE CONTENT ARE FORBIDDEN WITHOUT PERMISSION. OFFENDERS WILL BE HELD LIABLE FOR PAYMENT OF DAMAGES. ALL RIGHTS ARE RESERVED IN THE EVENT OF A PATENT GRANT OR REGISTRATION OF A UTILITY MODEL OR DESIGN.

Copyright © Quectel Wireless Solutions Co., Ltd. 2016. All rights reserved.

About the Document

History

Revision	Date	Author	Description
1.0	2016-07-18	Tiger CHENG	Initial
2.0	2016-09-27	Tiger CHENG	<ol style="list-style-type: none">1. Added figures for reference in Chapter 5.2. Added using main UART and UART3 to communicate with GNSS part in Chapter 5.3.3.

Quectel
Confidential

Contents

About the Document	2
Contents	3
Table Index	4
Figure Index	5
1 Introduction	6
1.1. Safety Information	7
2 Product Concept	8
2.1. MC60-TE-A Top and Bottom View	8
3 Interface Application of MC60-TE-A	10
3.1. SIM2 Card Interface	10
3.2. Test Points	11
4 MC60-TE-A Accessories Assembly	13
5 Illustration	14
5.1. Power on	14
5.2. Communicate with GSM Part of the Module	15
5.3. Communicate with GNSS Part of the Module	17
5.3.1. Use Main UART (All-in-one Solution)	17
5.3.2. Use UART3 (Stand-alone Solution)	17
5.3.3. Use Main UART and UART3	19
5.4. Firmware Upgrade through Main UART Port	20
5.5. Compatible Design and Applications	21
6 60-pin Assignment	23
7 Appendix A References	25

Table Index

TABLE 1: PINS OF SIM2 CARD INTERFACE	10
TABLE 2: PINS OF TEST POINTS.....	11
TABLE 3: PIN DEFINITION OF THE 60-PIN DIP CONNECTOR	23
TABLE 4: RELATED DOCUMENTS.....	25

Quectel
Confidential

Figure Index

FIGURE 1: MC60-TE-A TOP VIEW.....	8
FIGURE 2: MC60-TE-A BOTTOM VIEW.....	9
FIGURE 3: SIM2 CARD INTERFACE	10
FIGURE 4: TEST POINTS.....	11
FIGURE 5: MC60-TE-A TOOLKIT ACCESSORIES	13
FIGURE 6: CONNECTION BETWEEN MC60-TE-A AND GNSS/GSM ANTENNA	14
FIGURE 7: S101/S102 SWITCH STATUS INDICATION.....	15
FIGURE 8: S101/S102 SWITCH STATUS ON MAIN UART WHEN COMMUNICATING WITH GSM PART ...	15
FIGURE 9: S101/S102 SWITCH STATUS ON UART3 WHEN COMMUNICATING WITH GSM PART	16
FIGURE 10: S101/S102 SWITCH STATUS ON MAIN UART WHEN COMMUNICATING WITH GNSS PART	17
FIGURE 11: S101/S102 SWITCH STATUS ON UART3 WHEN COMMUNICATING WITH GNSS PART	18
FIGURE 12: USER INTERFACE OF POWERGPS TOOL.....	18
FIGURE 13: J106 SHORT CIRCUIT CONNECTION.....	19
FIGURE 14: S101/S102 SWITCH STATUS ON MAIN UART&UART3 WHEN COMMUNICATING WITH GNSS PART	19
FIGURE 15: SWITCH S101/S102 TO ON STATE.....	20
FIGURE 16: USING A PASSIVE ANTENNA	21
FIGURE 17: USING THE BUILT-IN BLUETOOTH ANTENNA.....	21
FIGURE 18: USING AN EXTERNAL BLUETOOTH ANTENNA.....	22
FIGURE 19: DIP CONNECTOR OF MC60-TE-A.....	23

1 Introduction

In order to help customers to develop applications with Quectel MC60 module, Quectel supplies corresponding evaluation board (EVB) kit and TE-A kit to test the module. This document can help customers quickly understand MC60-TE-A interface specifications, electrical and mechanical details and know how to use it.

MC60-TE-A is intended to be used in combination with GSM EVB for MC60 module testing and evaluation. For detailed description of GSM EVB, please refer to **document [4]**.

Quectel
Confidential

1.1. Safety Information

The following safety precautions must be observed during all phases of the operation, such as usage, service or repair of any cellular terminal or mobile incorporating Quectel module. Manufacturers of the cellular terminal should send the following safety information to users and operating personnel, and incorporate these guidelines into all manuals supplied with the product. If not so, Quectel assumes no liability for customer's failure to comply with these precautions.



Full attention must be given to driving at all times in order to reduce the risk of an accident. Using a mobile while driving (even with a handsfree kit) causes distraction and can lead to an accident. You must comply with laws and regulations restricting the use of wireless devices while driving.



Switch off the cellular terminal or mobile before boarding an aircraft. Make sure it is switched off. The operation of wireless appliances in an aircraft is forbidden, so as to prevent interference with communication systems. Consult the airline staff about the use of wireless devices on boarding the aircraft, if your device offers an Airplane Mode which must be enabled prior to boarding an aircraft.



Switch off your wireless device when in hospitals, clinics or other health care facilities. These requests are designed to prevent possible interference with sensitive medical equipment.



Cellular terminals or mobiles operating over radio frequency signal and cellular network cannot be guaranteed to connect in all conditions, for example no mobile fee or with an invalid SIM card. While you are in this condition and need emergent help, please remember using emergency call. In order to make or receive a call, the cellular terminal or mobile must be switched on and in a service area with adequate cellular signal strength.



Your cellular terminal or mobile contains a transmitter and receiver. When it is ON, it receives and transmits radio frequency energy. RF interference can occur if it is used close to TV set, radio, computer or other electric equipment.



In locations with potentially explosive atmospheres, obey all posted signs to turn off wireless devices such as your phone or other cellular terminals. Areas with potentially explosive atmospheres include fuelling areas, below decks on boats, fuel or chemical transfer or storage facilities, areas where the air contains chemicals or particles such as grain, dust or metal powders, etc.

2 Product Concept

2.1. MC60-TE-A Top and Bottom View

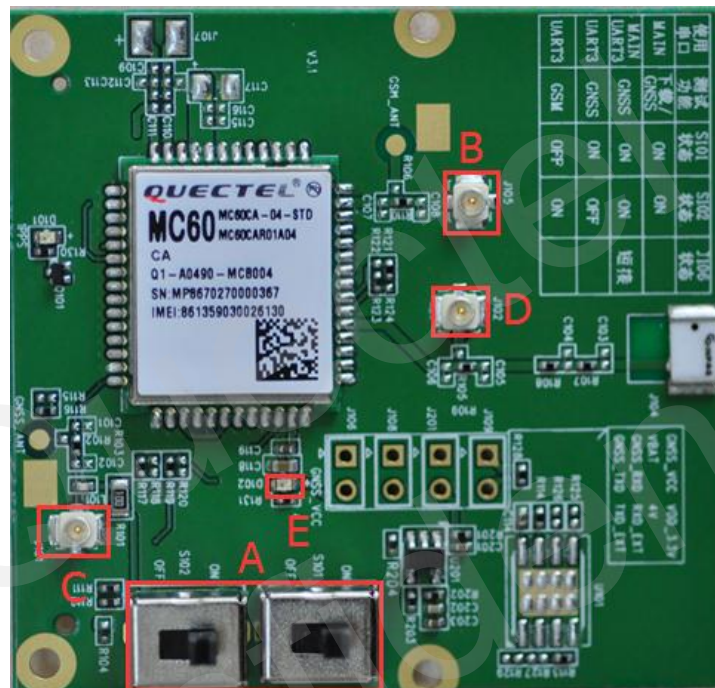

Figure 1: MC60-TE-A Top View

- A: Serial selector switch
- B: GSM antenna interface
- C: GNSS antenna interface
- D: BT antenna interface
- E: LED indicator



Figure 2: MC60-TE-A Bottom View

- F: SIM2 card interface
- G: Test points

NOTES

1. Some interfaces and test pins are reserved only for engineers to debug some functions which are not used for customers.
2. Some functions are only supported in certain software versions.

3 Interface Application of MC60-TE-A

3.1. SIM2 Card Interface



Figure 3: SIM2 Card Interface

Table 1: Pins of SIM2 Card Interface

Pin	Signal	I/O	Description
1	CD1		Connect to ground
2	CD2		Reserved
3	SIM_DATA	I/O	SIM card data I/O
4	SIM_CLK	O	SIM card clock
5	VPP		Reserved

6	SIM_RST	O	SIM card reset
7	GND		Ground
8	SIM_VDD		Power supply for SIM card
9	GND		Ground
10	GND		Ground

3.2. Test Points

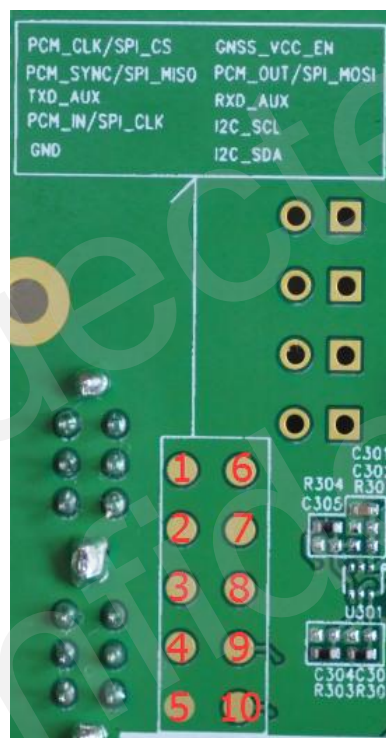

Figure 4: Test Points

Table 2: Pins of Test Points

Pin	Signal	I/O	Description
1	PCM_CLK/SPI_CS	O	PCM clock
2	PCM_SYNC/SPI_MISO	O	PCM frame synchronization
3	TXD_AUX	O	Transmit data

4	PCM_IN/SPI_CLK	I	PCM data input
5	GND		Ground
6	GNSS_VCC_EN	O	GNSS power enabled
7	PCM_OUT/SPI_MOSI	I/O	General purpose input/output port
8	RXD_AUX	I	Receive data
9	I2C_SCL28		Reserved
10	I2C_SDA28		Reserved

Quectel
Confidential

4 MC60-TE-A Accessories Assembly



Figure 5: MC60-TE-A Toolkit Accessories

- A: GNSS antenna
- B: CD
- C: GNSS antenna patch lead

5 Illustration

MC60-TE-A kit is intended to be used in combination with GSM EVB for MC60 module testing and evaluation. The connection between MC60-TE-A and GNSS/GSM antenna can refer to the following figure.



Figure 6: Connection between MC60-TE-A and GNSS/GSM Antenna

5.1. Power on

Power on procedure of MC60-TE-A is controlled by GSM EVB. Please refer to **document [4]** for detailed power on procedures.

5.2. Communicate with GSM Part of the Module

- (1) If the main UART is used for communication with GSM part of MC60 module, please turn the S101 and S102 switch to **ON** state on MC60-TE-A, and then connect the main UART of EVB to PC's USB port with the USB to UART converter cable. This is the recommended method. Switch status description is available in the following figures.

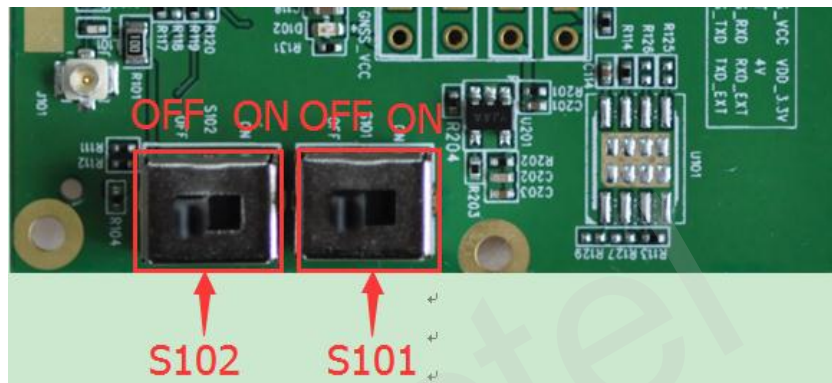

Figure 7: S101/S102 Switch Status Indication

使用串口	测试功能	S101 状态	S102 状态	J106 状态
MAIN	下载 / GNSS	ON	ON	
MAIN UART3	GNSS	ON	ON	短接
UART3	GNSS	ON	OFF	
UART3	GSM	OFF	ON	

Figure 8: S101/S102 Switch Status on Main UART When Communicating with GSM Part

If the UART3 is used for communication with the GSM part, please turn the S101 switch to **OFF** and S102 switch to **ON** state on MC60-TE-A, and then connect the UART3 on EVB to PC's USB port with the USB to UART converter cable. Currently, the software does not support this method.

使用 串口	测试 功能	S101 状态	S102 状态	J106 状态
MAIN	下载/ GNSS	ON	ON	
MAIN UART3	GNSS	ON	ON	短接
UART3	GNSS	ON	OFF	
UART3	GSM	OFF	ON	

Figure 9: S101/S102 Switch Status on UART3 When Communicating with GSM Part

- (2) Open the QCOM (AT command window) on PC. Set appropriate Baud Rate (such as 115200bps) and COM number which can be checked by the Device Manager on PC.
- (3) Connect the antenna to the GSM_ANT on MC60-TE-A with an RF cable.
- (4) Insert SIM card into the SIM card socket.
- (5) Insert earphone or handset into audio interface.
- (6) For power on procedure, please refer to **document [4]**.
- (7) After waiting for 2~3 seconds, customers should first input "AT" or "at" string once or more until receiving "OK" from the module in the HyperTerminal.

The module is set to autobauding mode in default configuration. This operation is to synchronize the baud rate between the computer and the module.

- (8) Input AT command and the module will execute its corresponding functions.

5.3. Communicate with GNSS Part of the Module

5.3.1. Use Main UART (All-in-one Solution)

- (1) Turn the S101 and S102 switch to **ON** state on MC60-TE-A, and then connect the main UART of EVB to PC's USB port with the USB to UART converter cable. This is the recommended method.

使用串口	测试功能	S101状态	S102状态	J106状态
MAIN	下载/ GNSS	ON	ON	
MAIN UART3	GNSS	ON	ON	短接
UART3	GNSS	ON	OFF	
UART3	GSM	OFF	ON	

Figure 10: S101/S102 Switch Status on Main UART When Communicating with GNSS Part

- (2) Open the QCOM (AT command window) on PC. Set appropriate Baud Rate (such as 115200bps) and COM number which can be checked by the Device Manager on PC.
- (3) Connect the antenna to the GNSS_ANT on MC60-TE-A with an RF cable.
- (4) For power on procedure, please refer to **document [4]**.
- (5) After waiting for 2~3 seconds, customers should first input "AT" or "at" string once or more until receiving "OK" from the module in the HyperTerminal.
- (6) Send corresponding AT commands to power on/off the GNSS part. When GNSS is powered on, the LED D102 on MC60-TE-A will be lighted and NMEA data will be output. For details of the corresponding AT commands, please refer to **document [1]**.

5.3.2. Use UART3 (Stand-alone Solution)

- (1) Turn the S101 switch to **ON** and S102 switch to **OFF** state on MC60-TE-A, and then connect the main UART of EVB to PC's USB port with the USB to UART converter cable.

使用 串口	测试 功能	S101 状态	S102 状态	J106 状态
MAIN	下载/ GNSS	ON	ON	
MAIN UART3	GNSS	ON	ON	短接
UART3	GNSS	ON	OFF	
UART3	GSM	OFF	ON	

Figure 11: S101/S102 Switch Status on UART3 When Communicating with GNSS Part

- (2) Connect the antenna to the GNSS_ANT on MC60-TE-A with an RF cable.
- (3) Insert the plug of the 5V power adapter. Turn the S202 switch to **ON** state on the EVB. The LED D503 on the EVB will be lighted.
- (4) Send **AT+QGNSSC=1** command via main UART to power on the GNSS part, the LED D102 on MC60-TE-A will be lighted. For details of the corresponding AT commands, please refer to **document [1]**.
- (5) Connect the UART3 of EVB to PC's USB port with the USB to UART converter cable. And NMEA data will be received via UART3 and PMTK commands can be sent via UART3.
- (6) The PowerGPS tool can be used to view the status of GPS&GLONASS receiver conveniently. When the tool is opened, the user interface as shown below will be displayed.

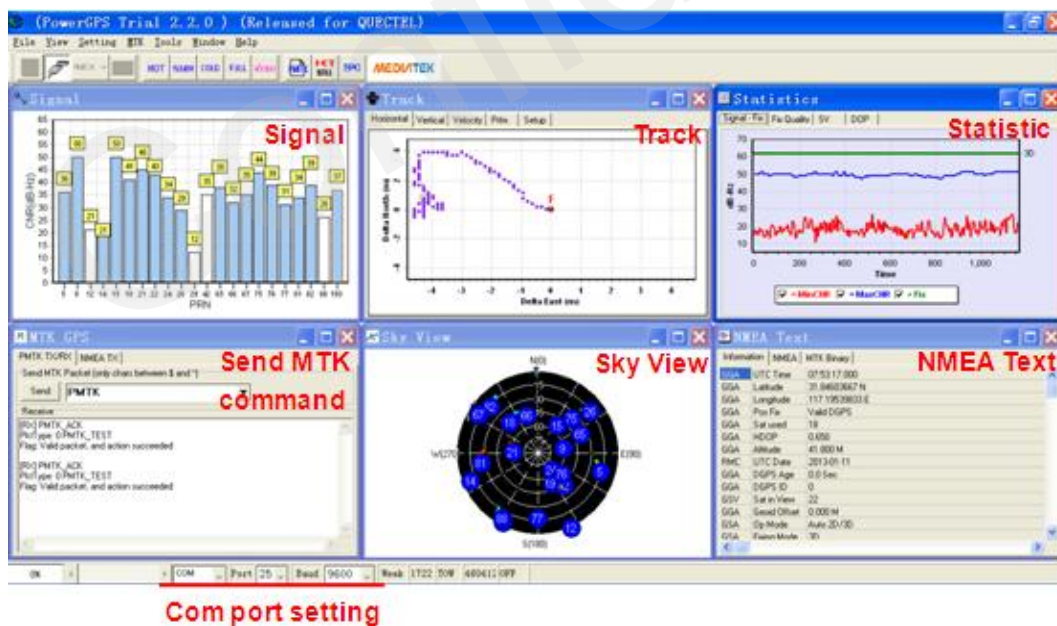

Figure 12: User Interface of PowerGPS Tool

5.3.3. Use Main UART and UART3

In this solution, customers can send AT commands about GNSS and get the data of GNSS via main UART. At the same time, NMEA data will be received from UART3.

- (1) Use a short circuit cap to connect the J106.

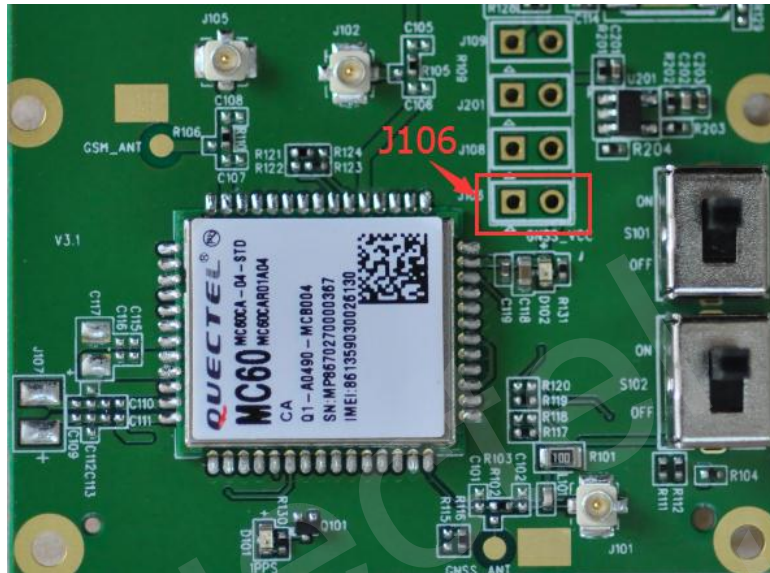

Figure 13: J106 Short Circuit Connection

- (2) Turn the S101 and S102 switch to **ON** state on MC60-TE-A, and then connect the main UART and UART3 of EVB to PC's USB ports with the USB to UART converter cables.

使用串口	测试功能	S101 状态	S102 状态	J106 状态
MAIN	下载/ GNSS	ON	ON	
MAIN UART3	GNSS	ON	ON	短接
UART3	GNSS	ON	OFF	
UART3	GSM	OFF	ON	

Figure 14: S101/S102 Switch Status on Main UART&UART3 When Communicating with GNSS Part

- (3) Connect the antenna to the GNSS_ANT on MC60-TE-A with an RF cable.
- (4) Insert the plug of the 5V power adapter. Turn the S202 switch to **ON** state on the EVB. The LED D503 on the EVB will be lighted.
- (5) Send **AT+QGNSSC=1** command via main UART to power on the GNSS part, the LED D102 on MC60-TE-A will be lighted. For details of the corresponding AT commands, please refer to **document [1]**.
- (6) Send AT commands about GNSS and get the data of GNSS via main UART
- (7) NMEA data will be received via UART3.

5.4. Firmware Upgrade through Main UART Port

- (1) Switch the S101 and S102 on MC60-TE-A to **ON** state.

使用串口	测试功能	S101状态	S102状态	J106状态
MAIN	下载/GNSS	ON	ON	
MAIN UART3	GNSS	ON	ON	短接
UART3	GNSS	ON	OFF	
UART3	GSM	OFF	ON	

Figure 15: Switch S101/S102 to On State

- (2) Start the firmware upgrade tool on PC.
- (3) Press the **START** button in the firmware upgrade tool.
- (4) Switch the S201 and S202 on the EVB to **ON** state. For details, please refer to **document [4]**.

5.5. Compatible Design and Applications

When testing the GNSS function, a passive antenna is recommended to be used. In this case, there is no need to mount Resistor R101 (10 ohm, 0805 package). If an active antenna is used, then R101 should be mounted.

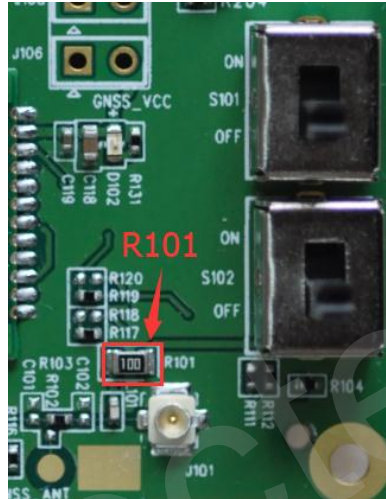

Figure 16: Using a Passive Antenna

When testing the BT function, the built-in Bluetooth antenna of MC60-TE-A is recommended to be used. In this case, resistor R109 (0 ohm, 0402 package) is mounted, while resistor R105 (0 ohm, 0402 package) is not mounted. If an external Bluetooth antenna is used, then R105 should be mounted and R109 should not be mounted.

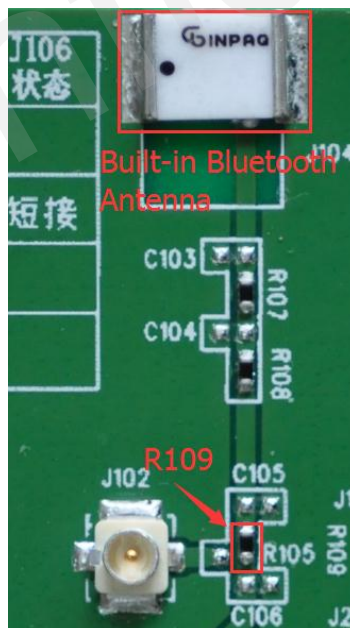

Figure 17: Using the Built-in Bluetooth Antenna

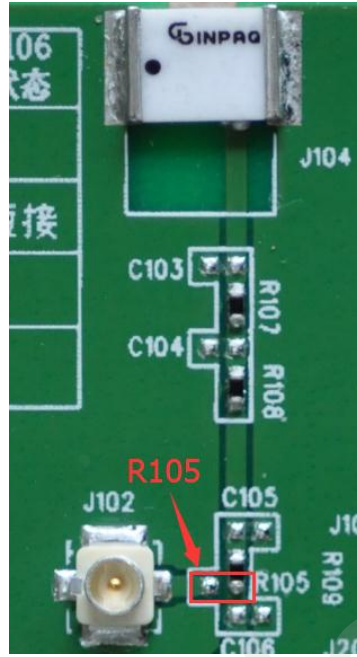

Figure 18: Using an External Bluetooth Antenna

Quectel
Confidential

6 60-pin Assignment

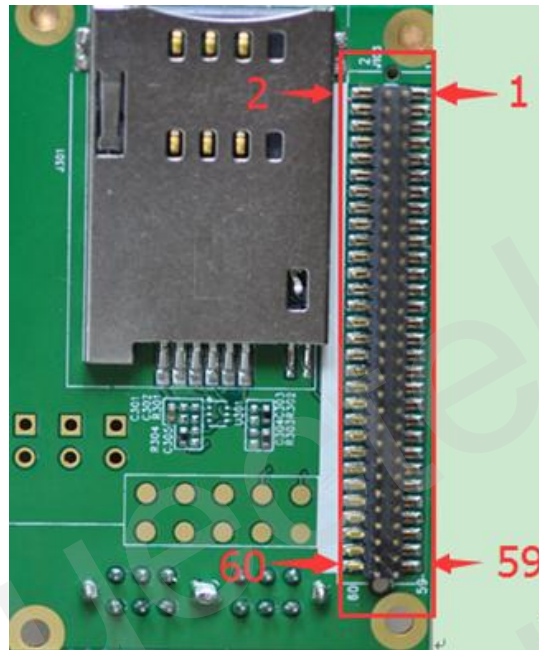

Figure 19: DIP Connector of MC60-TE-A

Table 3: Pin Definition of the 60-pin DIP Connector

Pin No.	Pin Name	I/O	Pin No.	Pin Name	I/O
1	VBAT	I	2	GND	
3	VBAT	I	4	GND	
5	VBAT	I	6	GND	
7	VBAT	I	8	GND	
9	VBAT	I	10	GND	
11			12	ADC0	I
13			14	VRTC	I/O
15	VDD_EXT	O	16	NETLIGHT	O

17	PWRKEY	I	18	KBR0	O
19			20	KBR1	O
21	GPIO0	I/O	22	KBR2	O
23			24	TXD3	O
25	SIM1_VDD	O	26	RXD3	I
27	SIM1_RST	O	28	KBC0	I
29	SIM1_DATA	I/O	30	KBC1	I
31	SIM1_CLK	O	32		
33	SIM1_PRESENCE	I	34		
35			36		
37	DCD	O	38	SD_CMD	O
39	DTR	I	40	SD_CLK	O
41	RXD	I	42	SD_DATA	I/O
43	TXD	O	44		
45	RTS	I	46		
47	CTS	O	48	DBG_RXD	I
49	RI	O	50	DBG_TXD	O
51			52		
53	SPK1P	O	54	MICP	I
55	SPK1N	O	56	MICN	I
57	SPK2P	O	58	MICP	I
59			60	MICN	I

7 Appendix A References

Table 4: Related Documents

SN	Document Name	Remark
[1]	Quectel_MC60_AT_Commands_Manual	MC60 AT commands manual
[2]	Quectel_GSM_UART_Application_Note	Serial port application note
[3]	Quectel_MC60_Hardware_Design	MC60 Hardware design
[4]	Quectel_GSM_EVB_User_Guide	GSM EVB user guide

Quectel
Confidential