

**DSO211AR TYPE SPXO SPECIFICATION**

1. Device Name           SPXO (Output Load Condition C-MOS)  
 2. Type                    DSO211AR  
 3. Frequency             12.000MHz  
 4. Absolute Maximum Value

	Item	Symbol	Rating	Unit
1	Supply Voltage	V <sub>CC</sub>	-0.5 ~ +5.0	V
2	Storage Temperature Range	T <sub>stg</sub>	-40 ~ +85	°C

5. Recommended Operating Conditions

	Item	Symbol	min.	typ.	max.	Unit
1	Supply Voltage	V <sub>CC</sub>	+3.0	+3.3	+3.6	V
2	Operating Temperature Range	T <sub>opr</sub>	-40	-	+85	°C
3	Output Load	L <sub>CMOS</sub>	-	-	15	pF

6. Electrical Characteristics

(T<sub>a</sub>=+25°C, V<sub>CC</sub>=+3.3V unless otherwise noted)

	Item	Symbol	Test Conditions	Limits			Unit
				min.	typ.	max.	
1	Frequency Stability	f <sub>tol</sub>	V <sub>CC</sub> =+3.3V ±0.3V T <sub>a</sub> =-40 ~ +85 °C	-50	-	+50	ppm
2	Supply Current	I <sub>CC</sub>	at No Load, #1pin:"H" or open	-	-	1.8	mA
	Standby Current	I <sub>std</sub>	#1pin:"L"	-	-	0.01	mA
3	Output Character		15pF				
	3-1.Symmetry	SYM	0.5V <sub>CC</sub> level	45	50	55	%
	3-2.Rise Time	t <sub>r</sub>	0.1V <sub>CC</sub> ~ 0.9V <sub>CC</sub>	-		5	ns
	3-3.Fall Time	t <sub>f</sub>	0.9V <sub>CC</sub> ~ 0.1V <sub>CC</sub>	-		5	ns
	3-4.Low Level	V <sub>OL</sub>		-	-	V <sub>CC</sub> ×0.1	V
	3-5.High Level	V <sub>OH</sub>		V <sub>CC</sub> ×0.9	-	-	V
4	Input Character						
	4-1.Output enable time	t <sub>pzl</sub>				1	ms
	4-2.Output disable time	t <sub>plz</sub>				150	ns
	4-3.Enable input	V <sub>IH</sub>		V <sub>CC</sub> ×0.8	-	-	V
	4-4.Disable input	V <sub>IL</sub>		-	-	V <sub>CC</sub> ×0.2	V

Measurement circuit and output wave form is refer to Fig.1. and Fig.2.

Date	Spec.NO	Rev.	Remark	Page.
2016/04/01	1XSG012000ARC	-	S16-018	1/3

# DSO211AR TYPE SPXO SPECIFICATION

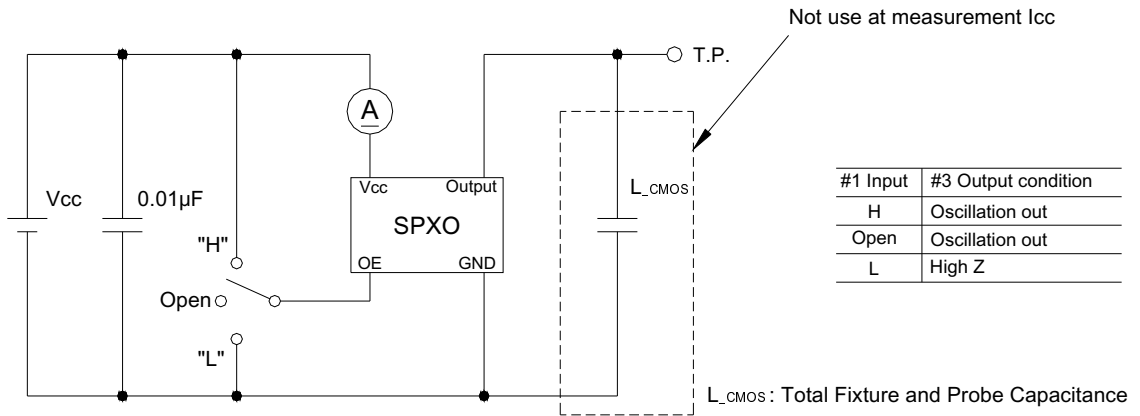

Fig.1.Measurement circuit

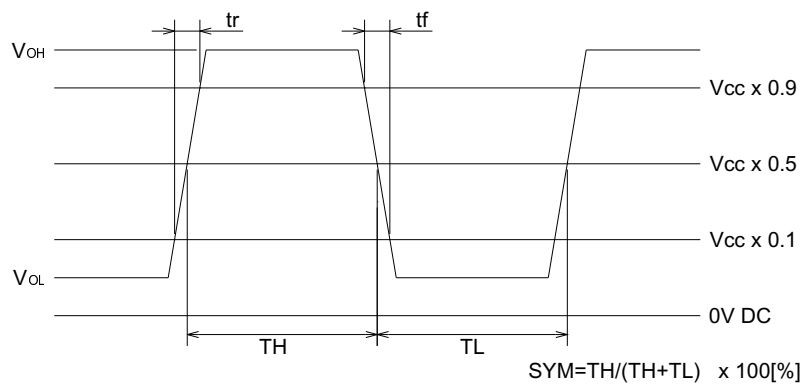

Fig.2.Output wave form

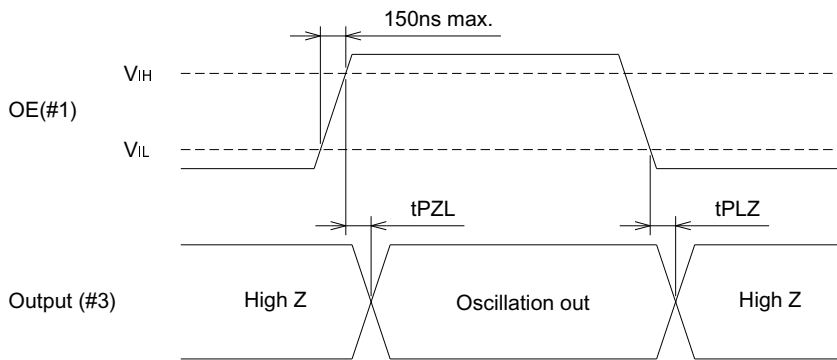
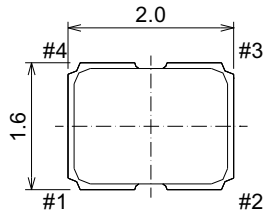

Fig.3.Input output condition

Date	Spec.NO	Rev.	Remark	Page.
2016/04/01 7. Outline, Pin Connections	1XSG012000ARC	-	S16-018	2/3

# DSO211AR TYPE SPXO SPECIFICATION



### Pin Connections

Pin No.	Connection
#1	OE(Output Enable)
#2	GND
#3	Output
#4	Vcc

Tolerance :  $\pm 0.1$

Unit : mm

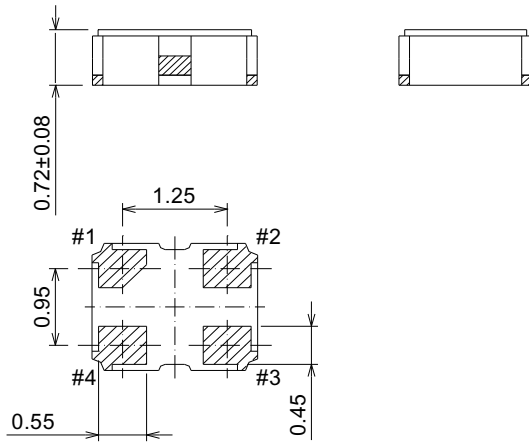

### Recommended Land Pattern <Tpo view>

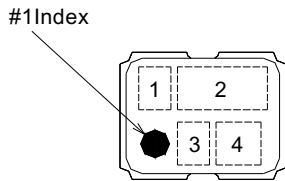
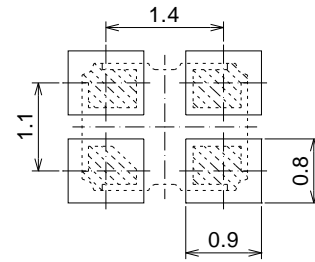

### 【Type Code】

Type	Marking
DSO211AR	R
DSO211AH	H
DSO211AB	B

- 1.Type : refer to 【Type code】
- 2.Nominal Frequency : 12.0  
(Include decimal point 4 digit)
- 3.KDS LOGO : D
- 4.Lot No.  
Year : Last digit of the year (e.g.2016 →6)  
Week : 2digit of the week (e.g.01~)

## 8. Supplement

### 8.1.Soldering

Peak-temperature 260°C 10sec max. , 2times max.

If the temperature is higher than 280 °C, there is a possibility for the sealing alloy to remelt.

### 8.2.Solder Iron

Bit temp.:350 °C max.,Time:3 s max., Each terminal solder a 1 time max.

Please take care so that a soldering iron should not touch a product directly.

Date	Spec.NO	Rev.	Remark	Page.
2016/04/01	1XSG012000ARC	-	S16-018	3/3